

Keyway Splice Box Quote Form

Name _____
 Company _____
 Address _____
 City/State _____
 Tel _____
 Email _____

Project name _____
 Project location _____
 Project Start _____

Comment

Using the diagrams below, please complete the form as much as possible. **Highlighted columns are required for quotation.**

Bar Mark	Length of Keyway (ft)	Box Style	Key Width (G)	Rebar Diameter	Plain / Epoxy	Rebar Spacing	Stirrup Type (if known)	Embedment (A)	Lap Length (C)	Stirrup Hook (B)	Stirrup Width (D)	Box Length (L) (if known)

Box Type	Standard Width	Standard Depth	Standard Length	Minimum Length	Maximum Length
60S	2.5"	1.5"	48"	24"	96"
100S	3.5"	1.5"	48"	24"	96"
160D	6"	1.5"	48"	24"	96"
160DD	6"	1.5"	48"	24"	96"

Custom sizes are quickly available for most project conditions

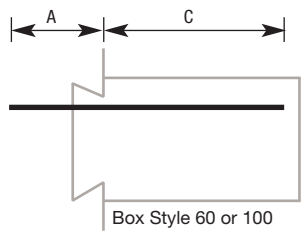
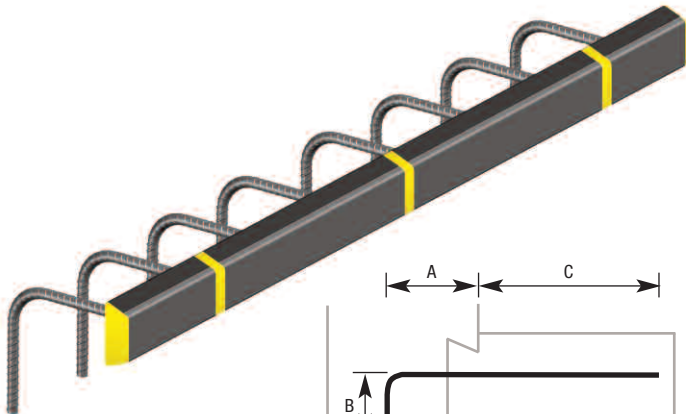

TYPE S: Straight Bar

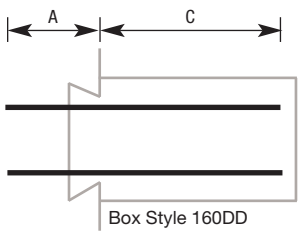

TYPE SS: Double Straight

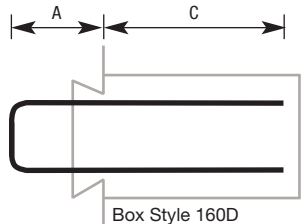

TYPE U: U Shaped Bar

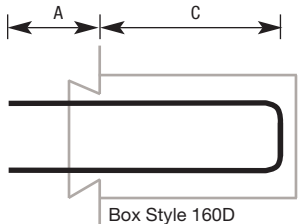

TYPE AU: Reverse U Shaped Bar

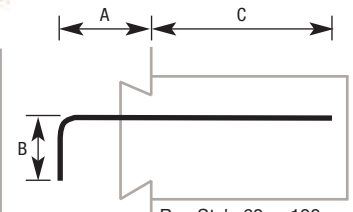

TYPE L: L Shaped Hook Bar

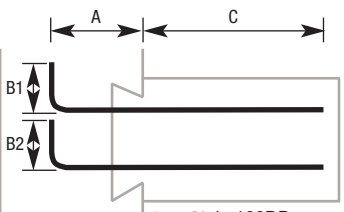

TYPE LL: Double L Shaped Hook Bar

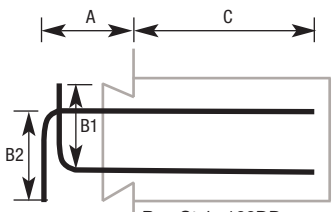

TYPE LJ: Double Angle Hook Bar