

Sandwich Panel Erection Anchors

Precast sandwich panel lifting

Overview

Leviat's Meadow Burke sandwich panel erection anchors are designed for safe and effective lifting and handling of precast concrete sandwich panels.

Reinforcement bars (available separately) are used to distribute the tension stress evenly into both concrete wythes. (See bottom of second page for more information).

Features

- **Simple Installation:** Leviat manufactures a variety of reusable void formers and holding plates - available separately - that make installation, stripping and ring clutch attachment simple and safe.
- **Quality:** Rapid Lift anchors are subject to extensive internal and third-party quality control processes. Leviat conducts quality

tensile tests down to 14° F to guarantee the ductile performance of its anchors at low temperature.

- **Versatility:** Rapid Lift Anchors can be used for edge lifting in the precast plant and on the jobsite. They can be manufactured with a plain or hot-dip galvanized finish.

RL-14 Sandwich Panel Erection Anchor

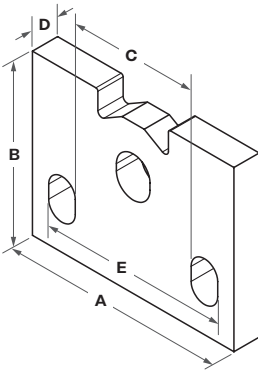

RL-15 Sandwich Panel Erection Anchor

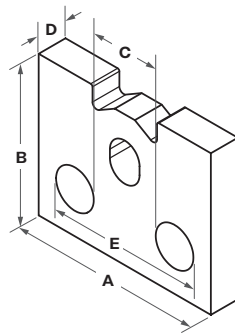

RL-16 Sandwich Panel Erection Anchor

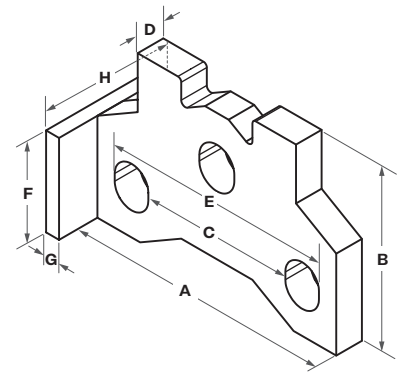

Dimensions - Sandwich Panel Erection Anchors

Anchor Name	Item Number	Anchor ID	Ring Clutch ID	A	B	C	D	E	Shear Plate (FxGxH)	Ultimate Mechanical Load Tension	Weight per Piece
RL-14	MB79077	4T	5T (MB79002)	6"	3 1/4"	1 13/16"	5/8"	4 3/8"	—	32,000 lbs	2.86 lbs
RL-14	MB79184	8T	10T (MB79003)	6"	4 3/4"	3 3/8"	3/4"	4 3/8"	—	64,000 lbs	5.05 lbs
RL-15	MB79217	4T	5T (MB79002)	4"	3 1/4"	2 1/16"	5/8"	2 3/8"	—	32,000 lbs	1.96 lbs
RL-16	MB79220C	4T	5T (MB79002)	4"	3 1/4"	2 1/16"	5/8"	2 3/8"	2" x 1/4" x 3"	32,000 lbs	2.38 lbs
RL-16	MB79184SP	8T	10T (MB79003)	6"	4 3/4"	3 3/8"	3/4"	2 3/8"	3 1/2" x 3/8" x 3"	64,000 lbs	5.20 lbs
RL-16	MB79301Gi	10T	10T (MB79003)	7"	4 3/4"	3 1/2"	3/4"	5"	2 5/8" x 3/8" x 3"	80,000 lbs	5.82 lbs

Sandwich Panel Erection Anchors

Precast sandwich panel lifting

Capacities - Sandwich Panel Erection Anchors

Panel Thickness	Anchor Name	Anchor ID	Concrete Strength	Tension	Shear Perpendicular to Panel Thickness SF = 4:1	Shear Parallel to Panel Thickness SF = 4:1	Rebar Size & Length Before Bending (L based on Detail A and Detail B)	Rebar Detail
2"x2"x2"	RL-15	4T	3,500 psi	6,500	748 lbs	3,750 lbs	#4 Grade 60 X 4'-0"	B
2"x2"x2"	RL-16	4T	3,000 psi	7,580	1,667 lbs	4,520 lbs	#4 Grade 60 X 4'-0"	B
4"x2"x2"	RL-14	4T	3,500 psi	8,000	3,390 lbs	8,000 lbs	#4 Grade 60 X A=4'-0", B=4'-0"	A (4" Wythe) & B (2" Wythe)
4"x2"x2"	RL-14	8T	4,500 psi	16,000	3,450 lbs	10,500 lbs	#5 Grade 60 X A=3'-6", B=5'-7"	A (4" Wythe) & B (2" Wythe)
4"x2"x2"	RL-16	8T	4,500 psi	16,000	3,450 lbs	10,500 lbs	#5 Grade 60 X A=3'-6", B=5'-7"	A (4" Wythe) & B (2" Wythe)
3"x2"x3"	RL-14	4T	3,500 psi	8,000	3,438 lbs	8,000 lbs	#4 Grade 60 X 3'-5"	A
3"x2"x3"	RL-14	8T	4,500 psi	16,000	2,992 lbs	9,400 lbs	#5 Grade 60 X 4'-6"	A
3"x2"x3"	RL-16	8T	4,500 psi	16,000	2,950 lbs	9,400 lbs	#5 Grade 60 X 4'-6"	A
3"x3"x3"	RL-16	10T	4,500 psi	20,000*	4,000 lbs	9,000 lbs	#6 Grade 60 X 5'-5"	B

Minimum edge distance is 2'-0"

*Tension value is limited by clutch capacity at 10T. To achieve this capacity, lifter must be installed using #6 tension bars

Rebar lengths are based on min. 2500psi concrete strength

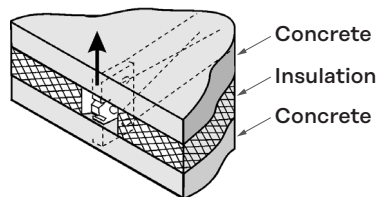

Shear perpendicular to panel thickness

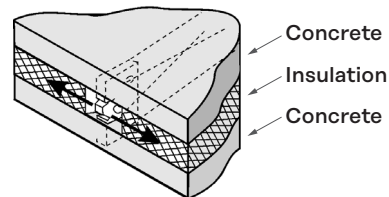

Shear parallel to panel thickness

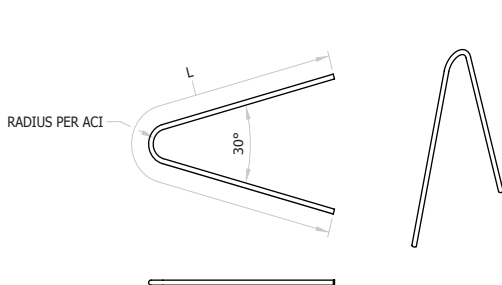

Detail A

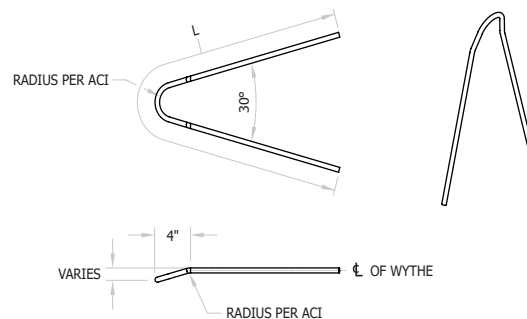

Detail B